

Quick Installation Guide

Blueberry Industrial Unmanged Gigabit Ethernet Switches

BU-1200 series

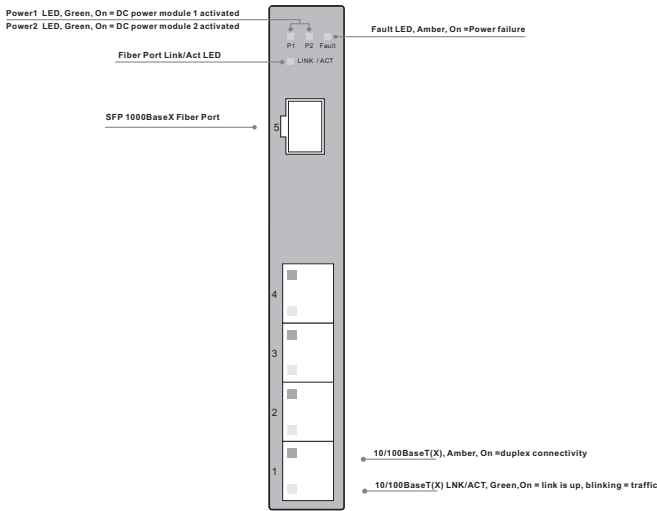

Interfaces	Description
10/100BASE-T(X) RJ45 ports	10/100Base-T(X) RJ-45 ports supporting: Auto-negotiation. Default Setting : Speed: auto Duplex: auto Flow control : disable
Terminal block (bottom)	Terminal block includes: PWR1, PWR2 (12-48V DC) and Relay output (1A@24VDC)
Fiber port	1 x 100BASE-X SFP port

Installation

DIN-Rail installation

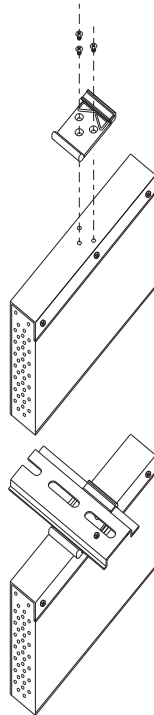

Wall-mounted installation

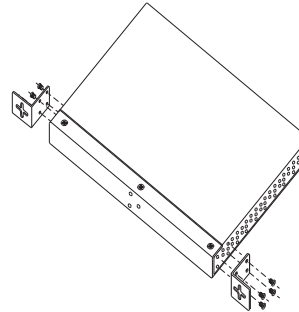

Accessories

① 6-Pin Terminal block

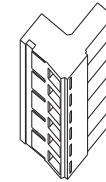

② Dust Cover (RJ-45)



③ Dust Cover (SFP)

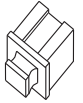

④ Round Screw (M3 X3)



⑤ Wall-mounted kit (for Slim Type)



⑥ 25mm DIN-Rail kit

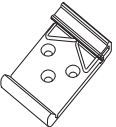

⑦ QIG

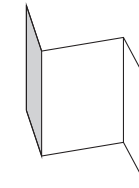

Power connection

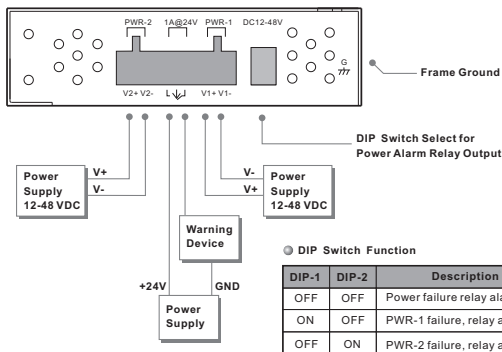

DIP Switch Function

DIP-1	DIP-2	Description
OFF	OFF	Power failure relay alarm disabled
ON	OFF	PWR-1 failure, relay alarm enabled
OFF	ON	PWR-2 failure, relay alarm enabled

Dimensions

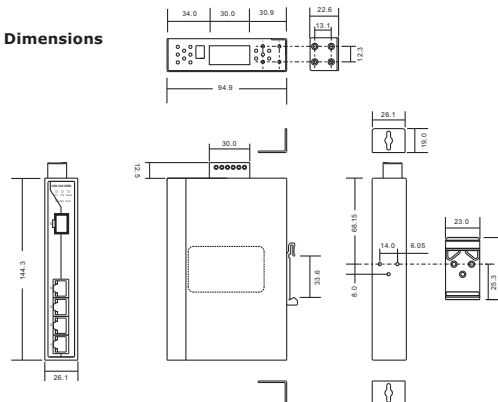

Packing list

Model name	Model Description	Accessories
BU-1200	Industrial 5-port Slim type Unmanaged Gigabit Ethernet Switch with 4x10/100/1000BASE-T and 1x1000Base-X SFP	⊗ X1, ⊗ X4, ⊗ X1, ⊗ X8, ⊗ X2, ⊗ X1, ⊗ X1