

Quick Installation Guide

Blueberry Industrial Unmanaged Fast Ethernet Switch

● **BU-108**

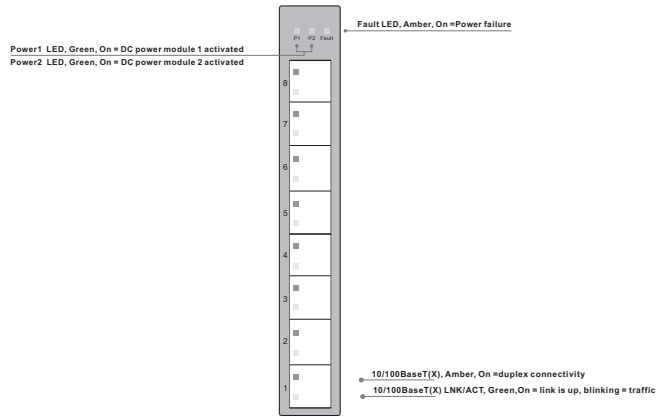

Interfaces	Description
10/100BASE-T(X) RJ45 ports	10/100Base-T(X) RJ-45 ports supporting: Auto-negotiation. Default Setting : Speed: auto Duplex: auto Flow control : disable
Terminal block (bottom)	Terminal block includes: PWR1, PWR2 (12-48V DC) and Relay output (1A@24VDC)

● **Power connection**

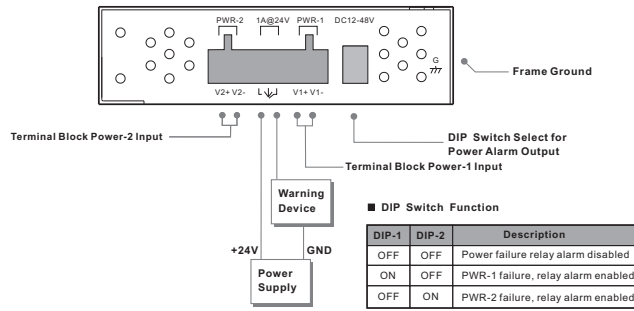

● **Installation**

■ **DIN-Rail Install Step**

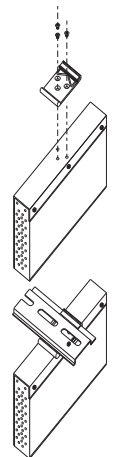

1. Slant the switch and mount the metal spring to the DIN rail
2. Push the switch towards the DIN rail until a «click» sound can be heard

● **Dimensions**

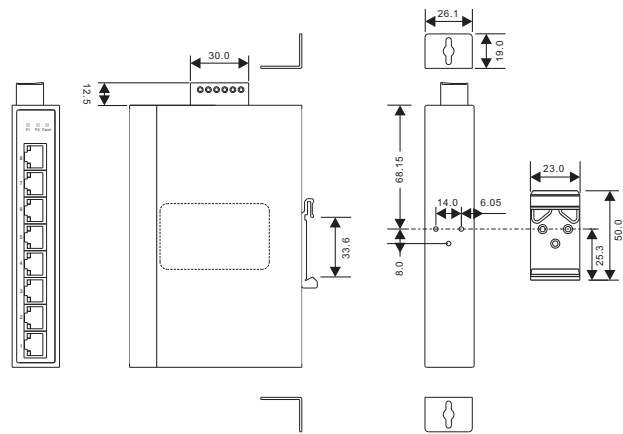

■ **Wall-mounted Install Step**

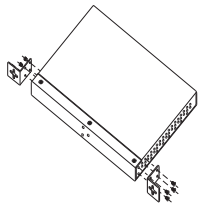

1. Remove the DIN clip
2. Use the six screws that can be found in the package in order to mount the wall mount panel (only use 3mm screws)
3. Mount the switch on the wall

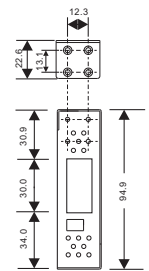

● **Accessories**

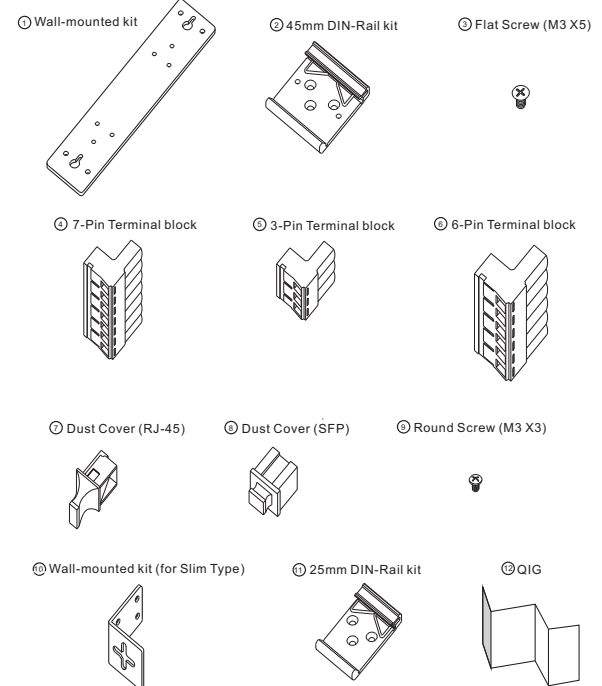

● **Packing list**

Model name	Model Description	Accessories
BU-108	Industrial 8-port unmanaged Ethernet switch with 8x10/100Base-T(X)	<ul style="list-style-type: none"> ① X 1, ② X 8, ③ X 2, ④ X 1, ⑤ X 1